

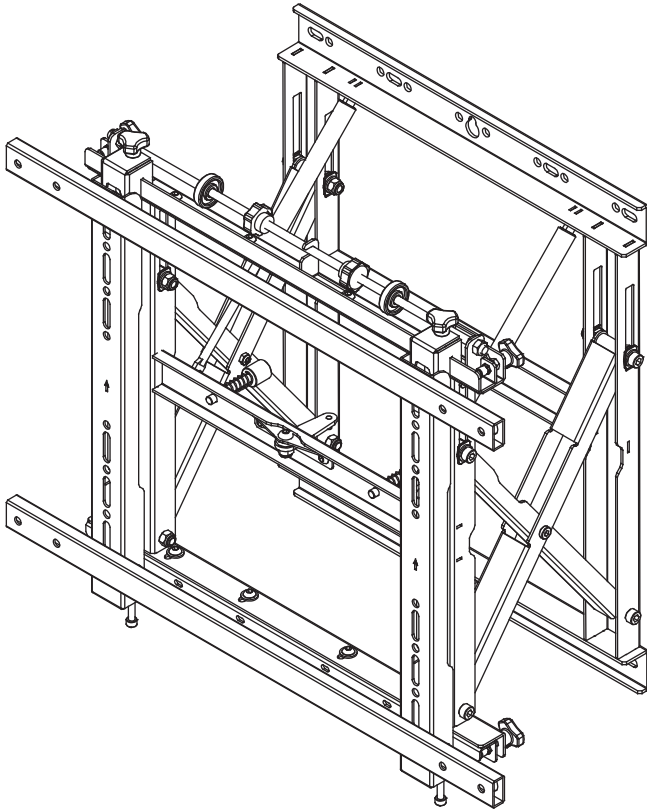

19"~70" Push-In Pop-Out TV Wall Mount Bracket



650325











INSTALLATION MANUAL

Weight Limit

Maximum Flat-panel Weight: **50 kg**







THE WALL STRUCTURE MUST BE CAPABLE OF SUPPORTING AT LEAST FIVE TIMES THE WEIGHT OF THE FLAT-PANEL. IF NOT, THE WALL STRUCTURE MUST BE REINFORCED.

Warning Statements

-  PRIOR TO THE INSTALLATION OF THIS PRODUCT, THE INSTALLATION INSTRUCTIONS MUST BE READ AND COMPLETELY UNDERSTOOD. KEEP THESE INSTALLATION INSTRUCTIONS IN AN EASILY ACCESSIBLE LOCATION FOR FUTURE REFERENCE.
-  PROPER INSTALLATION PROCEDURE BY A QUALIFIED SERVICE TECHNICIAN MUST BE FOLLOWED, AS OUTLINED IN THESE INSTALLATION INSTRUCTIONS. FAILURE TO DO SO COULD RESULT IN PROPERTY DAMAGE, SERIOUS PERSONAL INJURY, OR EVEN DEATH.
-  SAFETY MEASURES MUST BE PRACTICED AT ALL TIMES DURING THE ASSEMBLY OF THIS PRODUCT. USE PROPER SAFETY EQUIPMENT AND TOOLS FOR THE ASSEMBLY PROCEDURE TO PREVENT PERSONAL INJURY.
-  MANUFACTURER DOES NOT WARRANT AGAINST DAMAGE CAUSED BY THE USE OF ANY VPRODUCT FOR PURPOSES OTHER THAN THOSE FOR WHICH IT WAS DESIGNED OR DAMAGE CAUSED BY UNAUTHORIZED ATTACHMENTS OR MODIFICATIONS, AND IS NOT RESPONSIBLE FOR ANY DAMAGES, CLAIMS, DEMANDS, SUITS, ACTIONS OR CAUSES OF ACTION OF WHATEVER KIND RESULTING FROM, ARISING OUT OF OR IN ANY MANNER RELATING TO ANY SUCH USE, ATTACHMENTS OR MODIFICATIONS.
-  At least two qualified people should perform the assembly procedure. Personal injury and/or property damage can result from dropping or mishandling the flat-panel.
-  If mounting to wall studs or ceiling studs, make sure that the mounting screws are anchored into the center of the wall studs or ceiling studs. Use of an edge-to-edge stud finder is recommended.
-  It is recommended that a maximum of 1/2" plaster board be used when mounting to wooden studs.
-  Be aware of the mounting environment. If drilling and/or cutting into the mounting surface, always make sure that there are no electrical wires in wall. Cutting or drilling into an electrical line may cause serious personal injury.
-  Make sure there are no water or natural gas lines inside the wall where the mount is to be located. Cutting or drilling into a water or gas line may cause severe property damage or personal injury.
-  This product is intended for indoor use only. Use of this product outdoors could lead to product failure and/or serious personal injury.
-  Do not install near sources of high heat. Do not install on a structure that is prone to vibration, movement or chance of impact.

Installation Tools

The following tools may be required depending on your installation.

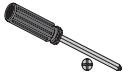
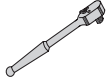
 Electronic Stud Finder	 Pencil	 Protective Eyewear	 Portable Drill	 1/4" Drill Bit
 Level	 1/2" Socket	 Phillips Head Screwdriver	 Socket Wrench	

Parts List

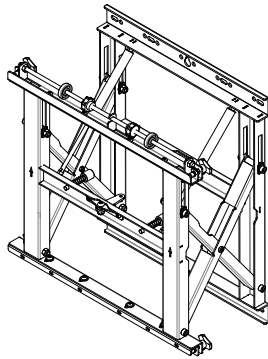

One-Latch Mounting Base -AA
(Qty 1)

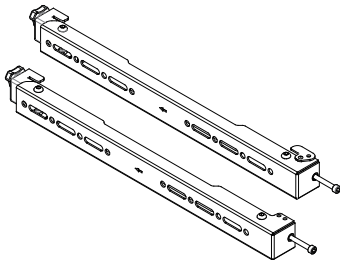



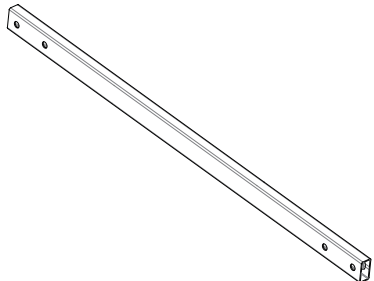









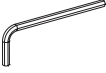

Left and Right Mounting Bracket -BB
(Qty 1 Each)



600mmX400mm adaptor
(Qty 2)-CC

Parts List (cont'd)

Mounting Hardware

<p>M5 x 16mm Screw -A (Qty 4)</p> 	<p>13x8.2x5 Spacer -I (Qty 8)</p> 
<p>M5 x 30mm Screw -B (Qty 4)</p> 	<p>5mm Allen Key -J (Qty 8)</p> 
<p>M6 x 16mm Screw -C (Qty 4)</p> 	<p>16x8.2x1.5 Metal washer -K (Qty 6)</p> 
<p>M6 x 30mm Screw -D (Qty 4)</p> 	<p>8*70 Lag Bolt -L (Qty 6)</p> 
<p>M8 x 16mm Screw -E (Qty 4)</p> 	<p>Anchor -M (Qty 6)</p> 
<p>M8 x 30mm Screw -F (Qty 4)</p> 	<p>13x8.2x13 Spacer -N (Qty 8)</p> 
<p>M8 x 50mm Screw -G (Qty 4)</p> 	<p>M8 x 15mm Screw -O (Qty 4)</p> 
<p>16x6.2x1.5 Metal washer -H (Qty 4)</p> 	

Features

The Video Wall Pop-Out Module is a customizable video wall mounting system featuring multi-monitor stacking, open design, and scissor mount extension. It has an extending scissor mount for easy installation, cable management and servicing.

Kickstand

Prop up the flat-panel with the kickstand for easy maintenance.

Post-Installation Adjustments

Leveling, tilt and in-out adjustment knobs make it easier than ever to flush and level the flat-panels for a seamless video wall.

Cable/Electrical Access

Allows for easy cable access and power distribution installations.

Locking Safety Screws

Prevent the flat-panel from being removed or dislodged from the mount. Use for added protection.

Spring Lock

Simply push the mounting rails in to lock or unlock the mount from the closed position.

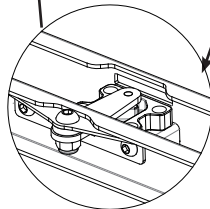
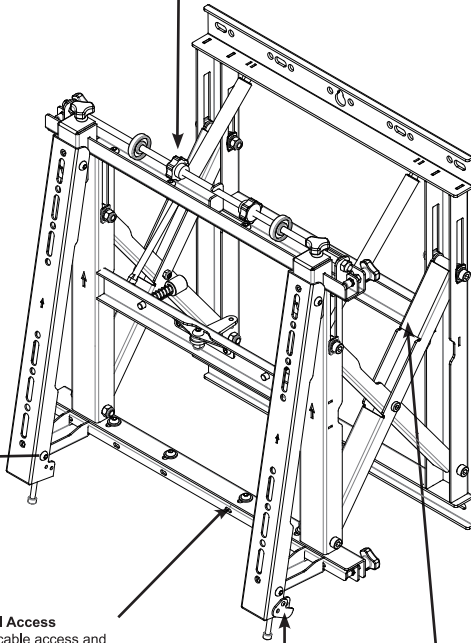
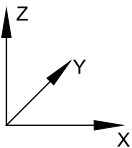

Installation

Introduction

Directional Mounting Arrow

The Directional Mounting Arrow stamped into the VV600 mount indicates which edge is the top.



Mounting Safety

Two people are recommended to install the mount.

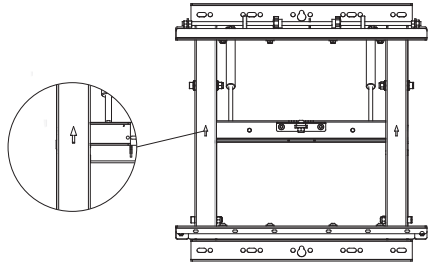

1) Mounting to Wooden Studs

Step 1

Two people are recommended for this step; one person to level the mount and another person to mark the wall stud location.

- 1) Place the mount against the wall in the desired viewing location.
- 2) Adjust the mount to align the mount slots in the mount with the center of the wall studs.
- 3) Level the mount.
- 4) Use a pencil to mark the upper right mounting location along the center of the wall stud.

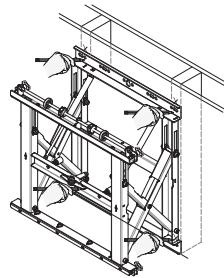

Step 2



Two people are recommended for this step; one person to level the mount and another person to drill the pilot holes.

Drill a "pilot hole" in the center of each of the marks with a power drill and a $\frac{1}{4}$ " drill bit.



Only use $\frac{1}{4}$ " drill bit when drilling the pilot holes.

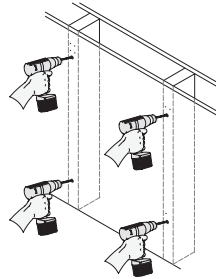

Step 3

- 1) Insert one (1) $\frac{5}{16}$ " x 4" lag bolt and one (1) $\frac{5}{16}$ " washer into each pilot hole
- 2) Tighten all lag bolts using a socket wrench and $\frac{1}{2}$ " socket.



Do not overtighten the lag bolts when attaching the mount to the wall. Improper installation may result in personal injury or property damage.

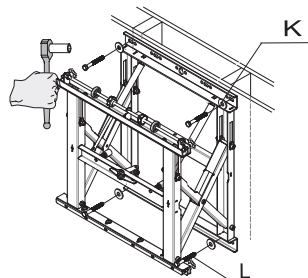

Installation

2) Mounting to Solid Concrete/Masonry

Step 1

Two people are recommended for this step; one person to level the mount and another person to mark the wall stud location.

- 1) Place the mount against the wall in the desired viewing location.
- 2) Adjust the mount to align the mount slots in the mount with the center of the wall studs.
- 3) Level the mount.
- 4) Use a pencil to mark the upper right mounting location along the center of the wall stud.

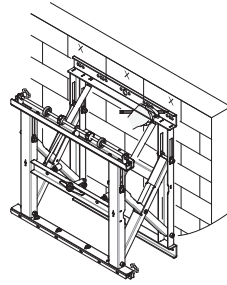

Step 2



Two people are recommended for this step; one person to level the mount and another person to drill the pilot holes.

Drill a "pilot hole" in the center of each of the marks with a power drill and a $\frac{1}{4}$ " drill bit.



Only use $\frac{1}{4}$ " drill bit when drilling the pilot holes.

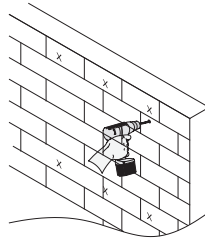

Step 3

Using a $\frac{3}{8}$ " (10 mm) masonry drill bit, drill 6 mounting holes 3-1/8" (80 mm) deep into the concrete/masonry surface.

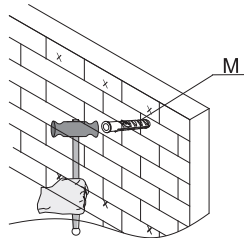

Step 4

- 1) Insert one (1) $\frac{5}{16}$ " x 6" lag bolt and one (1) $\frac{5}{16}$ " washer into each pilot hole
- 2) Tighten all lag bolts using a socket wrench and $\frac{1}{2}$ " socket.



Do not overtighten the lag bolts when attaching the mount to the wall. Improper installation may result in personal injury or property damage.

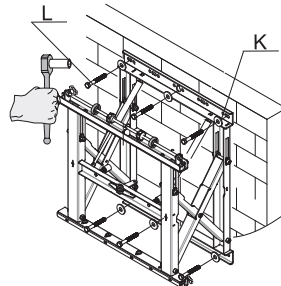

Installing the Mounting Brackets

- 1) After you have mounted the first bracket as described, draw a horizontal line (the use of a laser leveller may help).

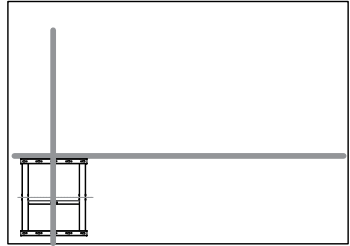

- 2) you can place the second bracket by tape measure proceed in this way with the other brackets.

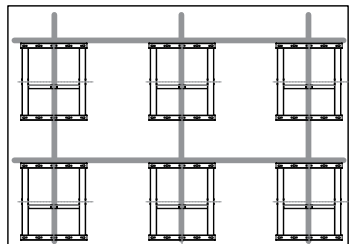
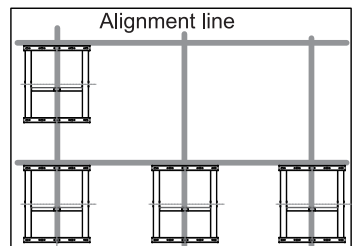
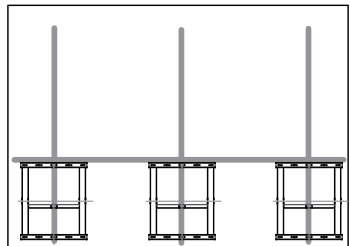
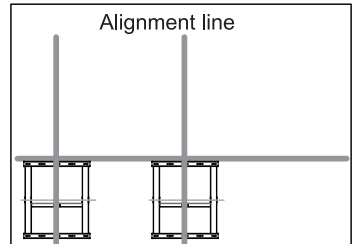

Installing the Mounting Bracket (cont'd)

⚠ VESA (Horizontal) :100*100~400*400

1)

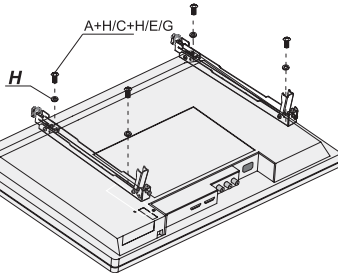

2)

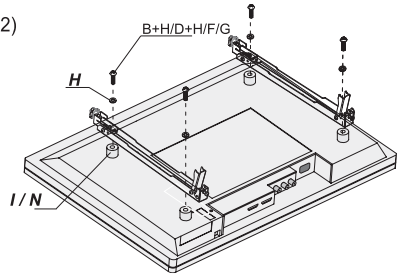

⚠ VESA:500*400~600*400

1)

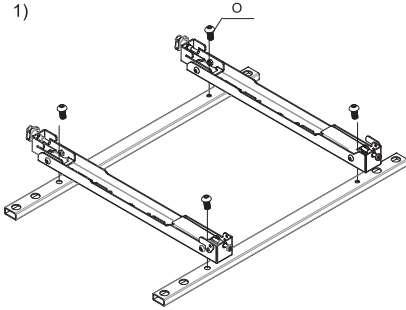

2)

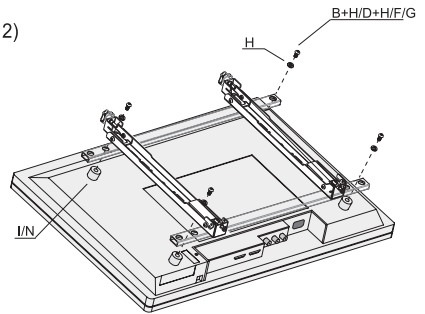

⚠ VESA (Vertical) :200*600~400*600

1)

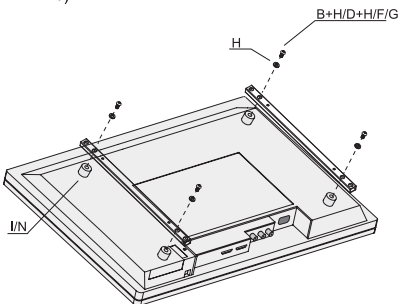

2)

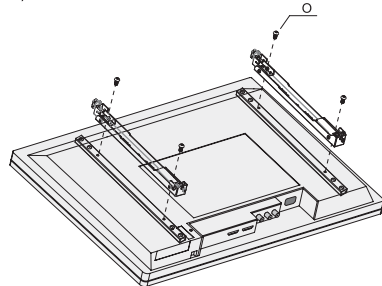

Mounting the Flat-Panel

Attaching the Flat-Panel to the Mount

- ⚠ Mounting bracket adjustments are factory pre-set (see **Note**).
- ⚠ This section requires two people.
- ⚠ Do not release your flat-panel until you are certain that top and bottom hooks of both mounting brackets are securely seated on the upper and lower mounting rails of the wall panel.

- 1) Raise the flat-panel past the top and bottom mounting rails on the wall panel.
- 2) Slide the flat-panel down slowly, keeping it close to the wall.
- 3) Engage the top and bottom mounting brackets to the rails of the mount.

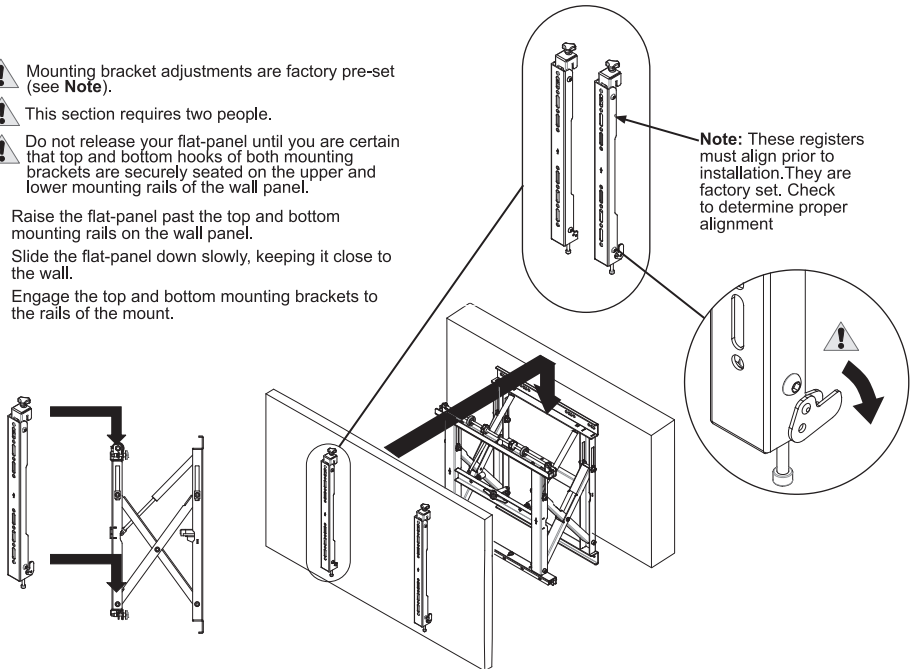

Locking Safety Screw & padlock Installation

- 1) Locate the pre-installed security locking safety screw at the bottom of each of the mounting brackets.
- 2) Use the Allen key (supplied) to tighten the locking safety screw.
- 3) The VW600 provide padlock installation on each bracket for anti-theft feature.

- ⚠ The locking safety screws keep the flat-panel from being accidentally dislodged from the VW600.
- ⚠ Do not overtighten the locking safety screws.

Option Padlock
feature 1 pcs per bracket
(not included)

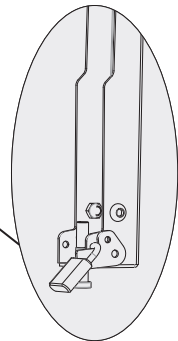

Post-Installation Adjustments

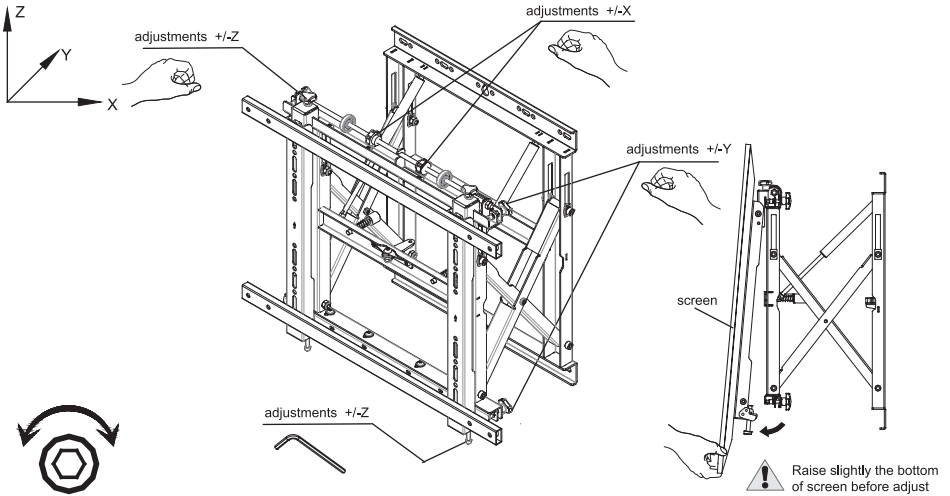

Maintenance and Servicing

- 1) Push evenly in the front of the VV600 to release the single latch spring lock (Figure 1).
- 2) Slowly pull the front of the VV600 to extend the scissor arms (Figure 2).
- 3) Loosen the locking safety screws on both mounting brackets.
- 4) Tilt up the bottom of the flat-panel, then set their kickstands against the bottom of the mount (Figures 2 & 3).

You can now reach behind the flat-panel for maintenance and servicing or replacement. After servicing, make sure the spring lock is locked again in the mount's closed position.

Latch Spring Lock

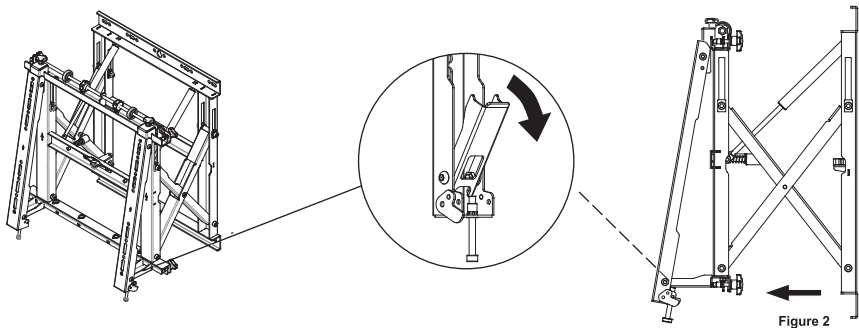
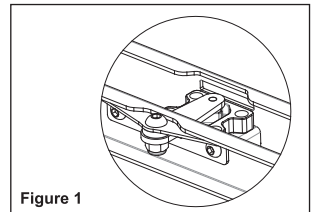

Technical Specifications

Move Inward

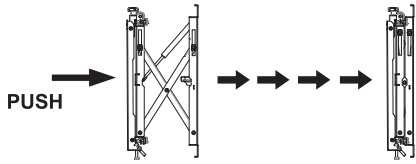

Move outward

